

REFERENCE SEASTROM WORKMANSHIP STD. 8.4.1.W2

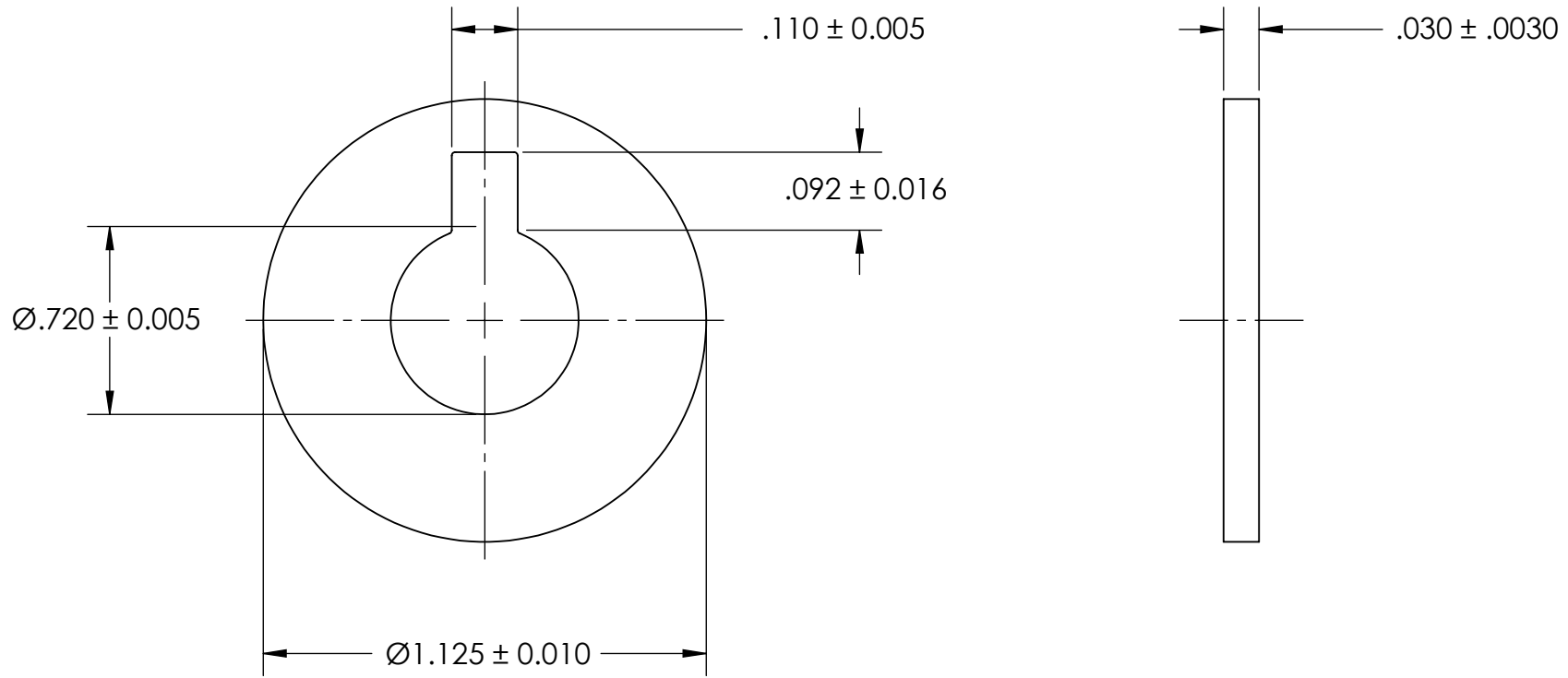

NOTES:

1. NONE

PROPRIETARY AND CONFIDENTIAL
 THE INFORMATION CONTAINED IN THIS DRAWING IS THE SOLE PROPERTY OF SEASTROM MANUFACTURING. ANY REPRODUCTION IN PART OR AS A WHOLE WITHOUT THE WRITTEN PERMISSION OF SEASTROM MANUFACTURING IS PROHIBITED.

DIMENSIONS ARE IN INCHES TOLERANCES: FRACTIONAL $\pm 1/32$ ANGULAR: MACH $\pm 1/2$ Deg TWO PLACE DECIMAL $\pm .01$ THREE PLACE DECIMAL $\pm .005$		NAME	DATE	SEASTROM MFG	
MATERIAL	FINISH	COMMENTS:			
COLD ROLLED STEEL	SEE NOTE 1	DRAWN		INTERNAL NOTCH WASHER	
		CHECKED			
		ENG APPR.			
		MFG APPR.			
		Q.A.		SIZE	DWG. NO.
				A	5750-16
				REV.	-
DRAWING IS NOT TO SCALE				SHEET 1 OF 1	