

REFERENCE SEASTROM WORKMANSHIP STD. 8.4.1.W2

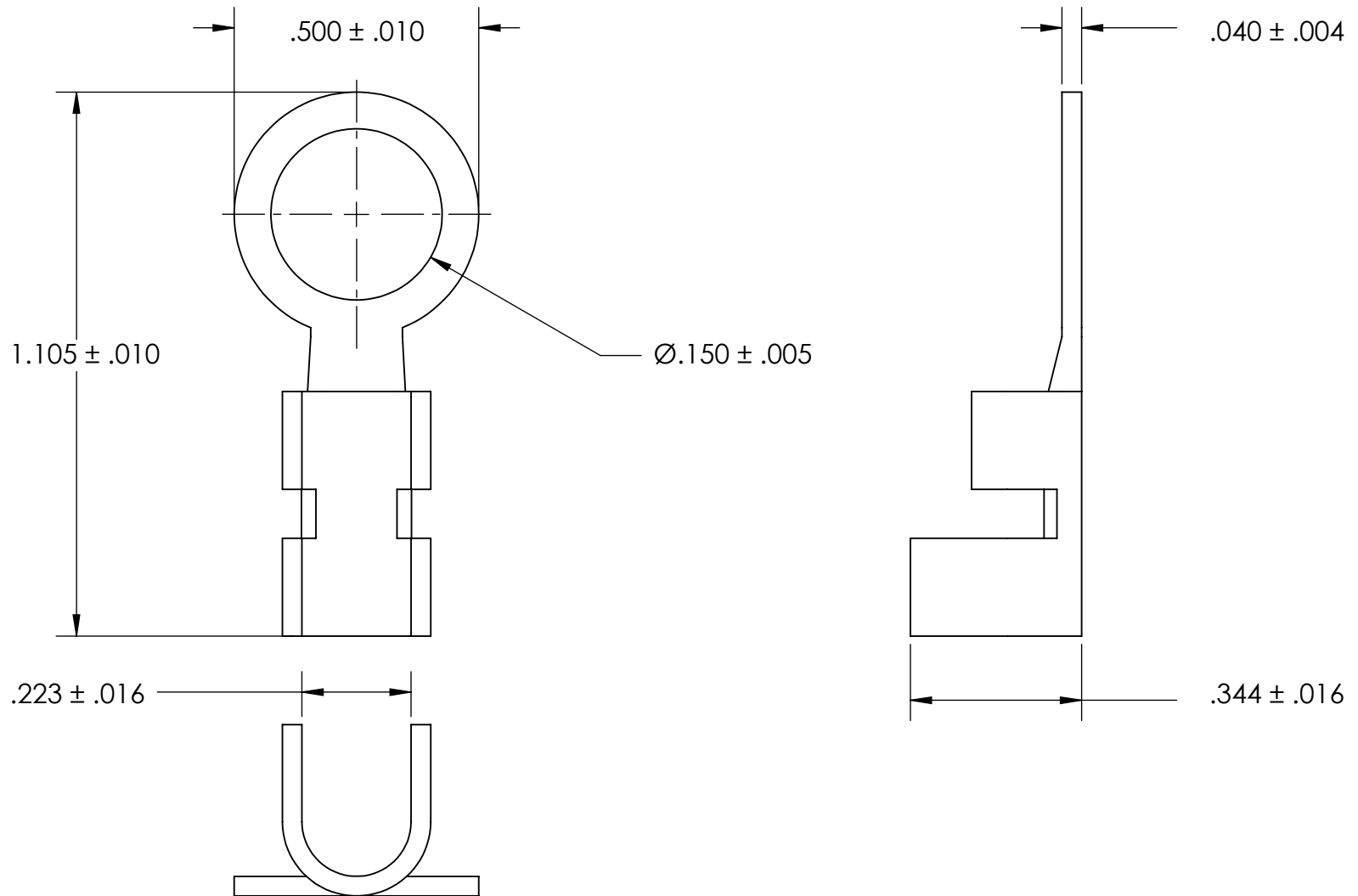

NOTES

1. BRIGHT TIN PLATE PER ASTM B545, CLASS B
2. SCREW SIZE: 6
3. DIMENSIONS APPLY PRIOR TO PLATING.

PROPRIETARY AND CONFIDENTIAL

THE INFORMATION CONTAINED IN THIS DRAWING IS THE SOLE PROPERTY OF SEASTROM MANUFACTURING. ANY REPRODUCTION IN PART OR AS A WHOLE WITHOUT THE WRITTEN PERMISSION OF SEASTROM MANUFACTURING IS PROHIBITED.

DIMENSIONS ARE IN INCHES TOLERANCES: FRACTIONAL $\pm 1/32$ ANGULAR: MACH $\pm 1/2$ Deg TWO PLACE DECIMAL $\pm .01$ THREE PLACE DECIMAL $\pm .005$	NAME	DATE	SEASTROM MFG		
	DRAWN				
	CHECKED		SOLDER LUG		
	ENG APPR.				
	MFG APPR.				
MATERIAL	COMMENTS:		SIZE	DWG. NO.	REV.
BRASS, HALF HARD			A	5454-9B	-
FINISH			SHEET 1 OF 1		
SEE NOTE 1					
DRAWING IS NOT TO SCALE					