

REFERENCE SEASTROM WORKMANSHIP STD. 8.4.1.W2

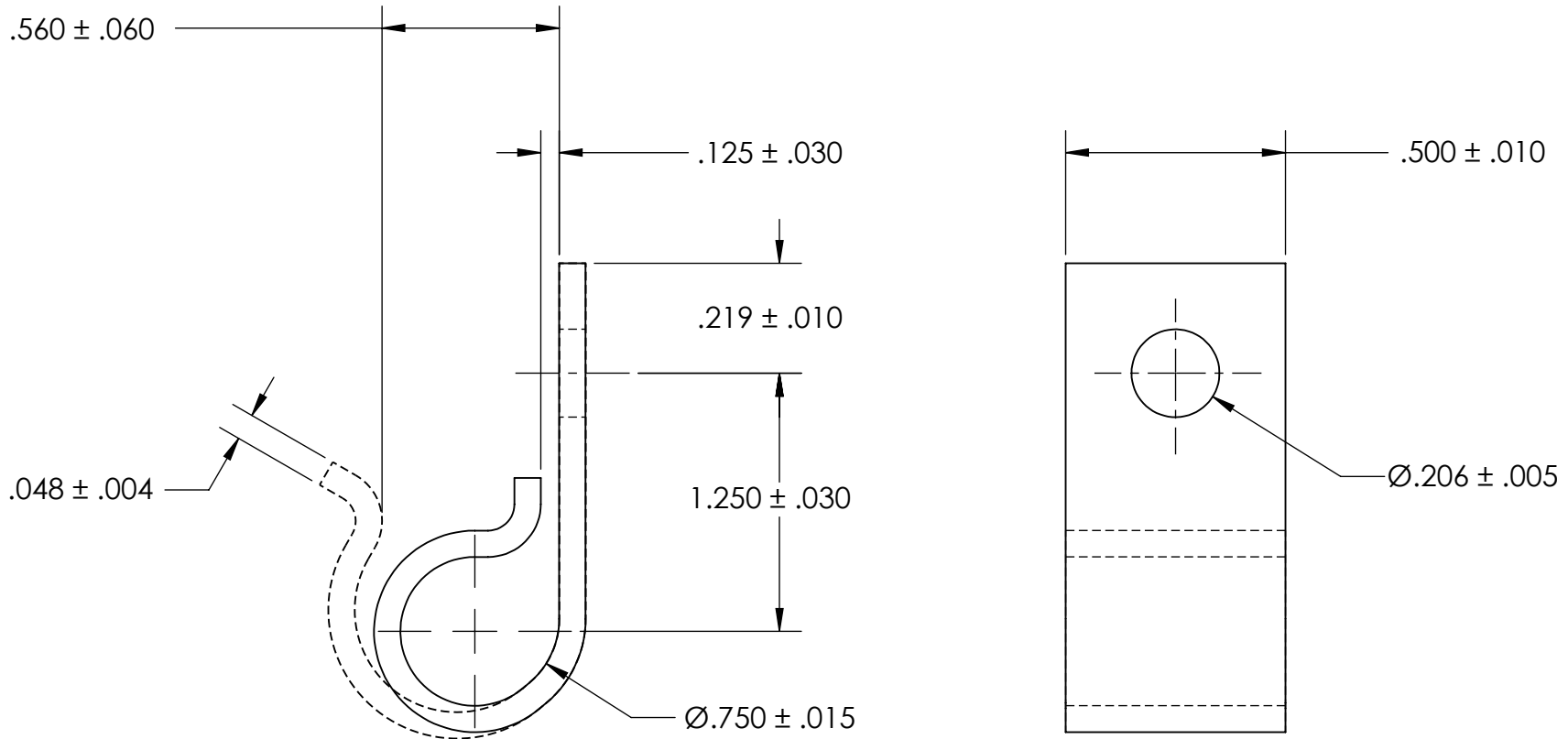

NOTES  
1. NONE

**PROPRIETARY AND CONFIDENTIAL**  
THE INFORMATION CONTAINED IN THIS DRAWING IS THE SOLE PROPERTY OF SEASTROM MANUFACTURING. ANY REPRODUCTION IN PART OR AS A WHOLE WITHOUT THE WRITTEN PERMISSION OF SEASTROM MANUFACTURING IS PROHIBITED.

DIMENSIONS ARE IN INCHES TOLERANCES: FRACTIONAL ± 1/32 ANGULAR: MACH ± 1/2 Deg TWO PLACE DECIMAL ± .01 THREE PLACE DECIMAL ± .005	NAME	DATE	SEASTROM MFG		
	DRAWN				J CLIP
	CHECKED		SIZE	DWG. NO.	
	ENG APPR.		A	5318-75-3	REV.
	MFG APPR.				-
MATERIAL	COMMENTS:		SHEET 1 OF 1		
300 SERIES STAINLESS					
FINISH					
SEE NOTE 1					
DRAWING IS NOT TO SCALE					