

REFERENCE SEASTROM WORKMANSHIP STD. 8.4.1.W2

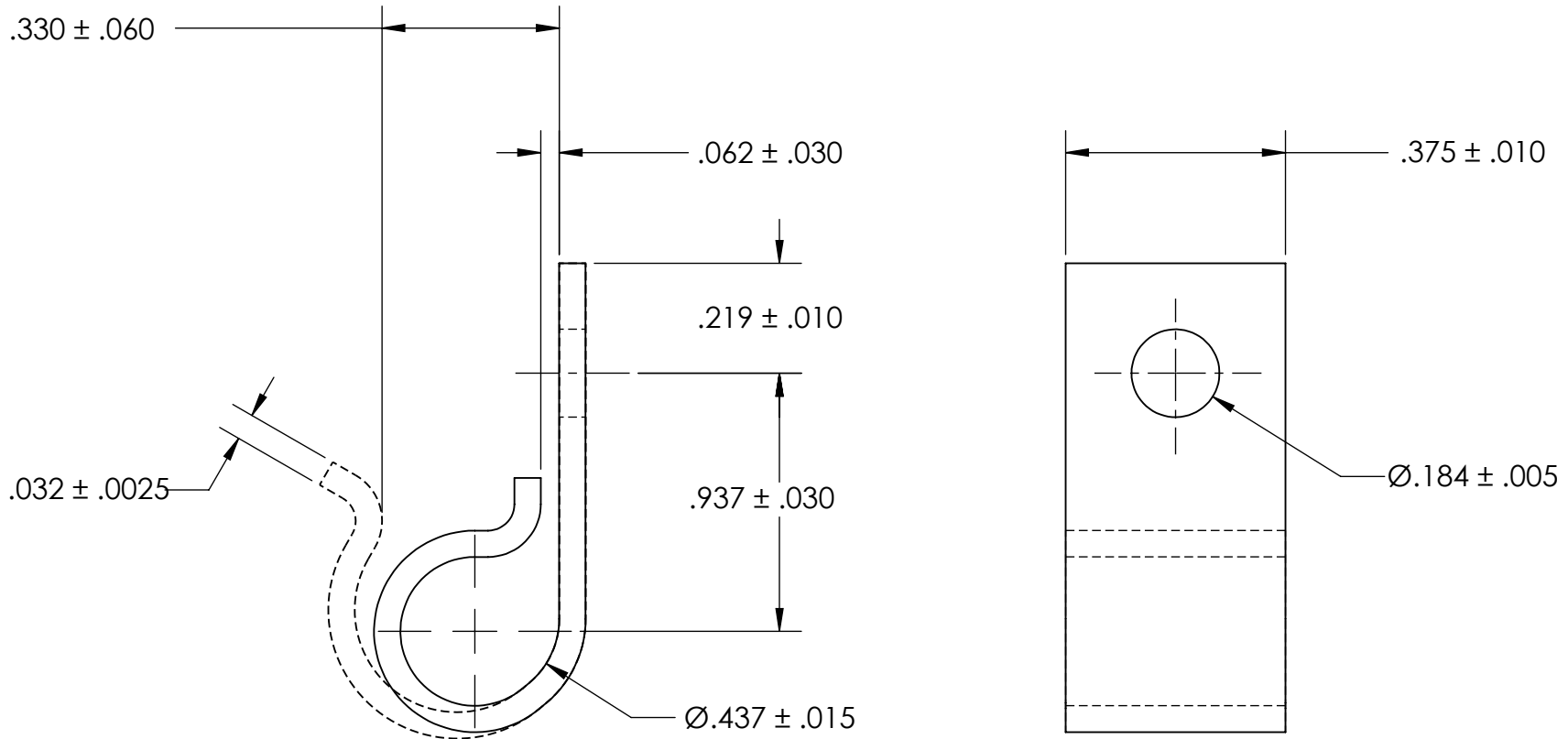

NOTES
1. NONE

PROPRIETARY AND CONFIDENTIAL
THE INFORMATION CONTAINED IN THIS DRAWING IS THE SOLE PROPERTY OF SEASTROM MANUFACTURING. ANY REPRODUCTION IN PART OR AS A WHOLE WITHOUT THE WRITTEN PERMISSION OF SEASTROM MANUFACTURING IS PROHIBITED.

DIMENSIONS ARE IN INCHES TOLERANCES: FRACTIONAL ± 1/32 ANGULAR: MACH ± 1/2 Deg TWO PLACE DECIMAL ± .01 THREE PLACE DECIMAL ± .005	NAME	DATE	SEASTROM MFG	
	DRAWN			
	CHECKED		J CLIP	
	ENG APPR.			
	MFG APPR.			
MATERIAL ALUMINUM	Q.A.		SIZE A	DWG. NO. 5318-43-1
FINISH SEE NOTE 1	COMMENTS:		REV. -	
DRAWING IS NOT TO SCALE				SHEET 1 OF 1