

REFERENCE SEASTROM WORKMANSHIP STD. 8.4.1.W2

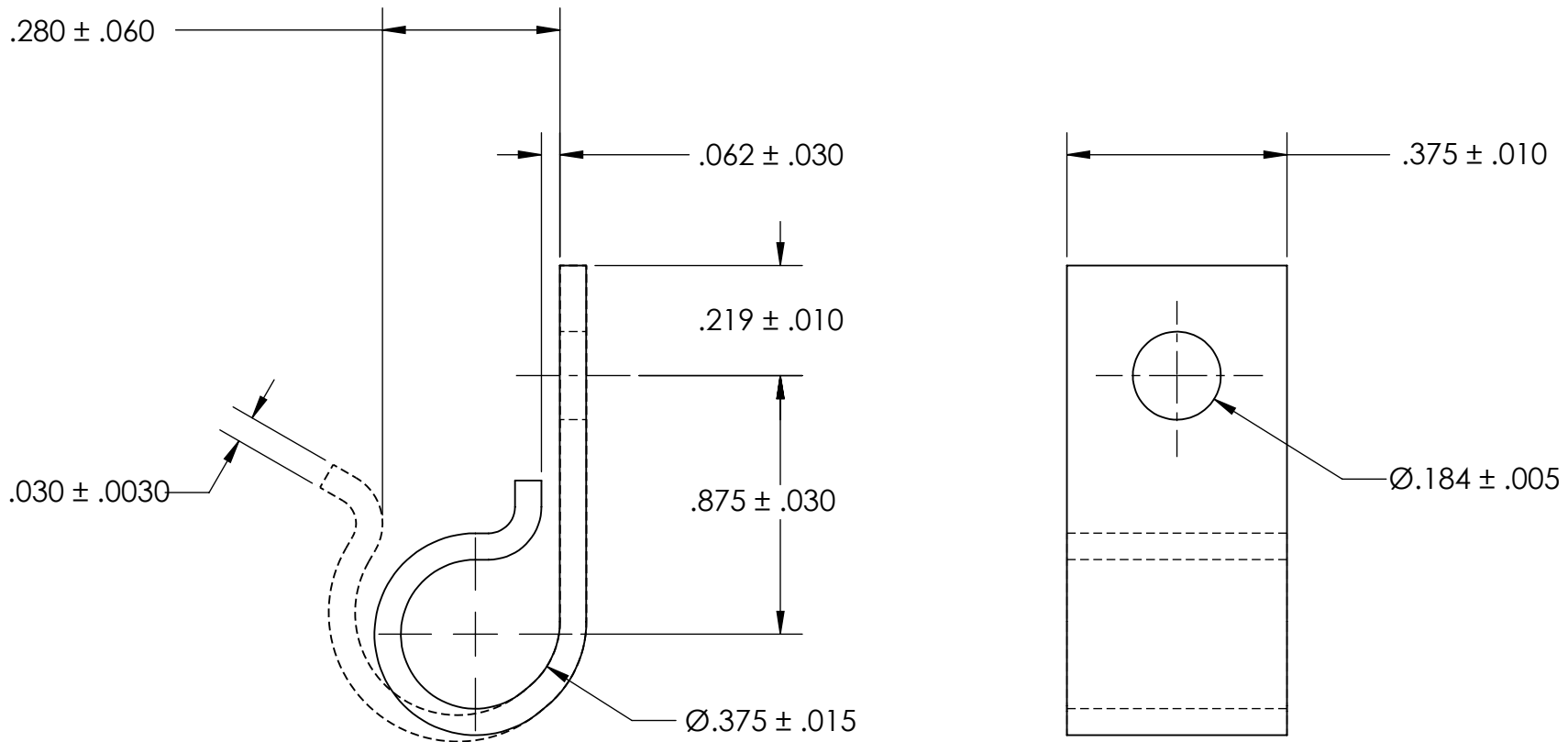

NOTES

1. ZINC PLATE PER ASTM B633, SC1, TYPE III or V, Clear
2. DIMENSIONS APPLY PRIOR TO PLATING.

PROPRIETARY AND CONFIDENTIAL
 THE INFORMATION CONTAINED IN THIS DRAWING IS THE SOLE PROPERTY OF SEASTROM MANUFACTURING. ANY REPRODUCTION IN PART OR AS A WHOLE WITHOUT THE WRITTEN PERMISSION OF SEASTROM MANUFACTURING IS PROHIBITED.

DIMENSIONS ARE IN INCHES TOLERANCES: FRACTIONAL ± 1/32 ANGULAR: MACH ± 1/2 Deg TWO PLACE DECIMAL ± .01 THREE PLACE DECIMAL ± .005	NAME	DATE	SEASTROM MFG		
	DRAWN				
	CHECKED		J CLIP		
	ENG APPR.				
	MFG APPR.				
MATERIAL	Q.A.		SIZE	DWG. NO.	REV.
COLD ROLLED STEEL	COMMENTS:		A	5318-37-2	-
FINISH			SHEET 1 OF 1		
SEE NOTE 1					
DRAWING IS NOT TO SCALE					