

REFERENCE SEASTROM WORKMANSHIP STD. 8.4.1.W2

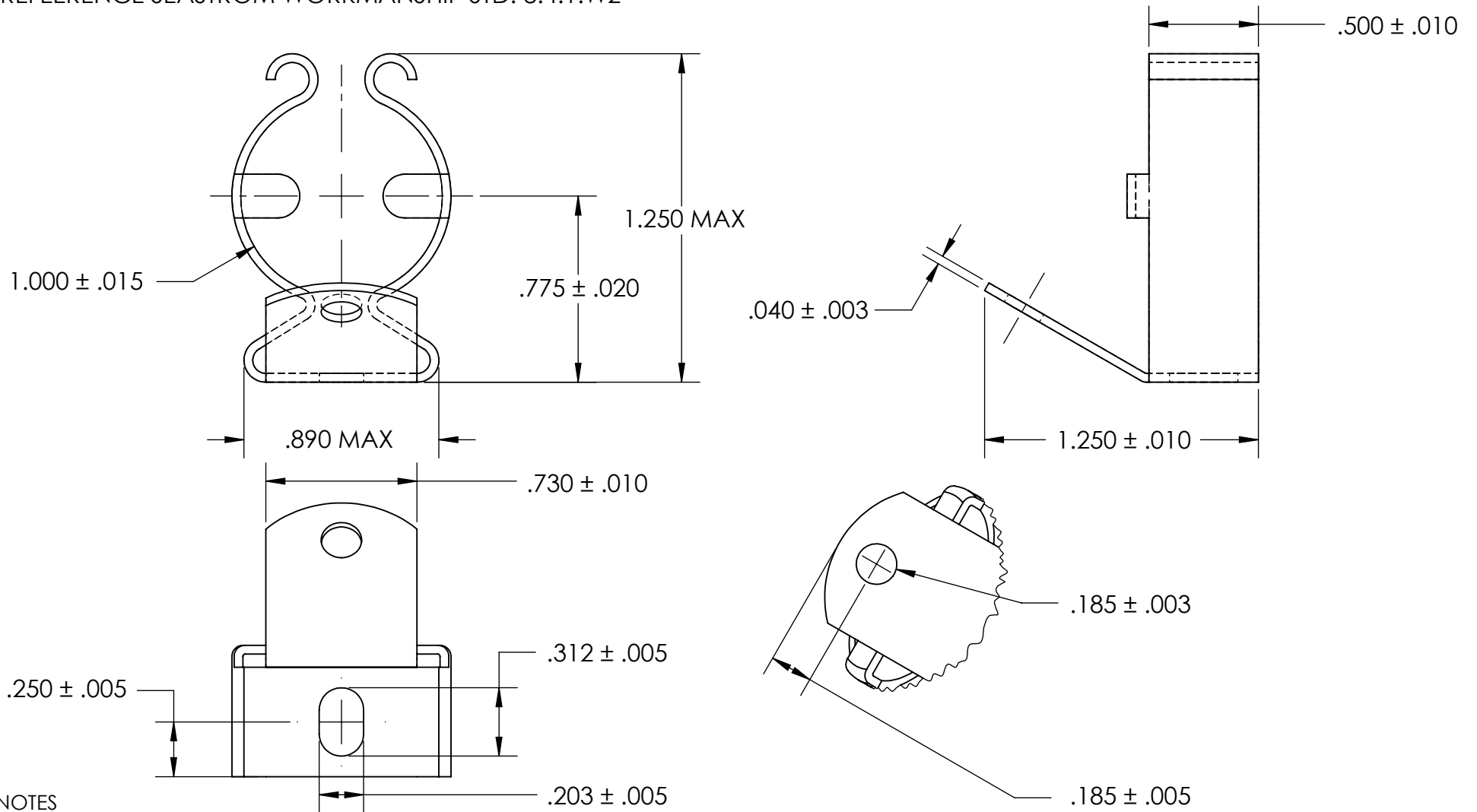

NOTES

1. BERYLLIUM COPPER, ANNEALED
2. HEAT TREAT: 73-79 HR15N
3. NICKEL PLATE PER AMS QQ-N-290 CLASS 1 GRADE G
4. DIMENSIONS ARE TAKEN WITH THE PART CLAMPED TO A FLAT SURFACE AND A DUMMY COMPONENT IN PLACE.
5. DIMENSIONS APPLY PRIOR TO PLATING.

**PROPRIETARY AND CONFIDENTIAL**

THE INFORMATION CONTAINED IN THIS DRAWING IS THE SOLE PROPERTY OF SEASTROM MANUFACTURING. ANY REPRODUCTION IN PART OR AS A WHOLE WITHOUT THE WRITTEN PERMISSION OF SEASTROM MANUFACTURING IS PROHIBITED.

DIMENSIONS ARE IN INCHES TOLERANCES: FRACTIONAL $\pm 1/32$ ANGULAR: MACH $\pm 1/2$ Deg TWO PLACE DECIMAL $\pm .01$ THREE PLACE DECIMAL $\pm .005$	NAME	DATE	SEASTROM MFG	
	DRAWN			
	CHECKED		SPRING CLIP	
	ENG APPR.			
	MFG APPR.			
MATERIAL SEE NOTE 1	Q.A.		SIZE <b>A</b>	DWG. NO. 4570-100-124-1-N
HEAT TREAT SEE NOTE 2	COMMENTS:		REV. -	
FINISH SEE NOTE 3	DRAWING IS NOT TO SCALE		SHEET 1 OF 1	