

REFERENCE SEASTROM WORKMANSHIP STD. 8.4.1.W2

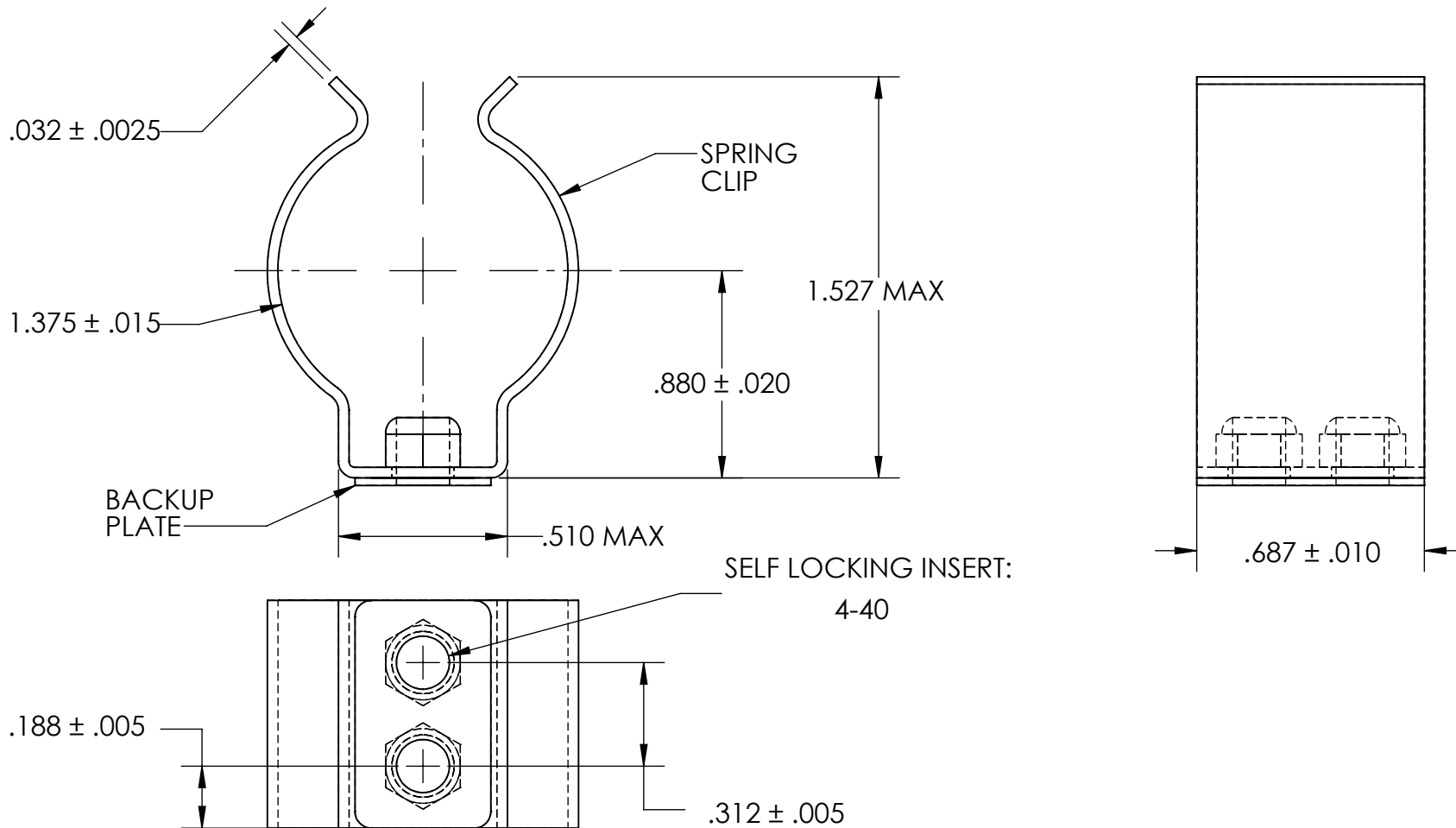

NOTES

1. BERYLLIUM COPPER, ANNEALED

2. HEAT TREAT: 73-79 HR15N

(SPRING CLIP ONLY)

3. NONE

(SPRING CLIP AND BACKUP PLATE)

4. DIMENSIONS ARE TAKEN WITH THE PART CLAMPED TO A FLAT SURFACE AND A DUMMY COMPONENT IN PLACE.

PROPRIETARY AND CONFIDENTIAL

THE INFORMATION CONTAINED IN THIS DRAWING IS THE SOLE PROPERTY OF SEASTROM MANUFACTURING. ANY REPRODUCTION IN PART OR AS A WHOLE WITHOUT THE WRITTEN PERMISSION OF SEASTROM MANUFACTURING IS PROHIBITED.

DIMENSIONS ARE IN INCHES TOLERANCES: FRACTIONAL ± 1/32 ANGULAR: MACH ± 1/2 Deg TWO PLACE DECIMAL ± .01 THREE PLACE DECIMAL ± .005		NAME	DATE	SEASTROM MFG
MATERIAL SEE NOTE 1	DRAWN			
HEAT TREAT SEE NOTE 2	CHECKED			SPRING CLIP
FINISH SEE NOTE 3	ENG APPR.			
	MFG APPR.			
	Q.A.			
	COMMENTS:			
	SIZE	DWG. NO.	REV.	
	A	4543-137-68-1	-	
DRAWING IS NOT TO SCALE				SHEET 1 OF 1